

**BEANIE BEAR**



★ 4 ♣ 1 ♠ 1 ♣ 1 ♠

Collect her and her 3,000 plushy bear sisters!

**BEAR ROSS**



★ 8 ♣ 1 ♠ 1 ♣ 1 ♠

Be careful, or you'll be this bear's next "happy little accident."

**BROWN BEAR**



★ 5 ♣ 2 ♠ 2 ♣ 2 ♠

Don't let him hug you!

**FAT BEAR**

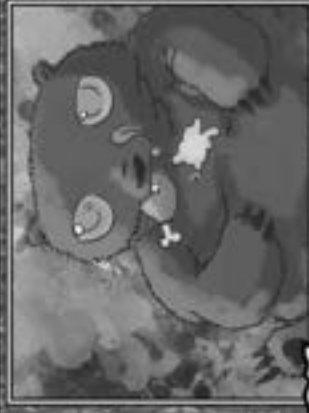

★ 7 ♣ 5 ♠ 1 ♣ 1 ♠

Lightly jog away to protect your food.

**GRATEFUL BEAR**



★ 8 ♣ 2 ♠ 2 ♣ 2 ♠

This bear is grateful it's not dead.

**HIPSTER BEAR**



★ 10 ♣ 2 ♠ 2 ♣ 2 ♠

They'll steal all of your soy-based, gluten-free, non-GMO food!

**KOALA BEAR**



★ 5 ♣ 1 ♠ 1 ♣ 1 ♠

Technically not a bear, but still a menace to society.

**MOLAR BEAR**



★ 10 ♣ 3 ♠ 3 ♣ 3 ♠

Take a closer look at those pearly whites! He won't bite! Much.

**PANDA BEAR**



★ 6 ★ -2 -2

*The only bear that knows kung fu.*

**PASTA BEAR**



★ 8 ★ -1 -1

*Jah know e's da most carb-loaded bear around!*

**RASTA BEAR**



★ 8 ★ -1 -1

*Jah know e's da mellowest bear around!*

**ARSON BEAR**

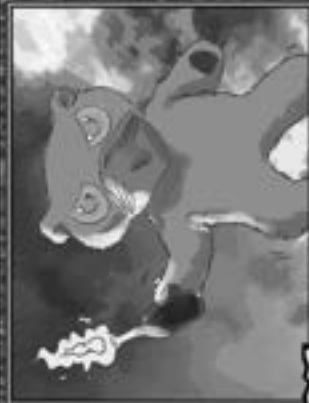

★ 15 ★ -3 -2

*Only he can cause forest fires!*

**BEARRITO**



★ 13 ★ -3 -3

*This bear put my favorite taco stand out of business.*

**BOXER BEAR**



★ 18 ★ -3 -3

*He didn't hear no bell!*

**BUGGY BEAR**



★ 13 ★ -2 -2

*This monstrosity comes from a realm I cannot remember.*

**CIRCUS BEAR**



★ 13 ★ -2 -2

*The only thing stronger than this bear's bite is its crippling depression.*

**DM BEAR**

11 ♀ -2 ♀ -2 ♀ 2 ♀

*This bear has mastered all dungeons. He's still working on dragons... and talking to girls.*

**EMO BEAR**

13 ♀ -2 ♀ -2 ♀ 2 ♀

*The edgiest bear of all. Emo Bear non-conforms by dressing in a clearly defined style.*

**FEMALE MAIL BEAR**

16 ♀ -3 ♀ -3 ♀ 3 ♀

*You'll see her delivering "Salmon of the Month" subscriptions.*

**GOOD OL' BEAR**

14 ♀ -2 ♀ -2 ♀ 1 ♀

*Just a good ol' bear, never meaning no harm. Well, some harm.*

**GRIZZLY BEAR**

16 ♀ -3 ♀ -3 ♀ 3 ♀

*Her favorite hobbies include catching salmon and attacking composites!*

**GUMMY BEAR**

13 ♀ -2 ♀ -2 ♀ 2 ♀

*The stickiest bear in the woods. Tastes like artificial orange!*

**POO BEAR**

12 ♀ -2 ♀ -2 ♀ 2 ♀

*You'll smell him long before you see him.*

**SKATER BEAR**

12 ♀ -2 ♀ -2 ♀ 2 ♀

*She said, "See you later, bear!"*

**THREE BEARS**

16 -3 3

Stay away from their porridge, or they'll eat you instead!

**TRIBEARATOPS**

16 -2 3

A science experiment turned theme park attraction. Surely nothing could go wrong!

**YOGA BEAR**

13 -1 2

Hey, hey, this bear is a true yogi.

**COSMONAUT BEAR**

23 -4 4

Comrade Cosmonaut Bear wants to destroy the Capitalist system... and YOU!

**CYBEAR**

18 -4 5

A mad scientist tried creating super bears for a league of justice.

**MERBEAR**

20 -4 4

This bear wants legs so it can be part of our world... and eat us!

**PIRATE BEAR**

21 -5 4

The scourge of the seven seas (but mostly the duck pond).

**RABID BEAR**

23 -5 8

The last bear you'd want to be bitten by, except maybe a zombie bear or vampire bear.

**SHORT-FACED BEAR**

25 -7 8

The worst bear of them all. He can gobble up an entire campsite!

**SIR BEARINGTON THE NOBLE**

19 -4 4

Knighted by the King of Bears for having slain the evil Park Ranger, John the Picnicker.

**BACKPACK**

3 3 1

Algebra won't save you now. The algebra textbook, maybe.

**BEAR CLAW**

4 4 2

Defeat those bears with your bear hands!

**BEAR CLAW**

4 4 2

Defeat those bears with your bear hands!

**BEAR SPRAY**

-4 -4 2

-4 Strength to a Bear or Camper until the end of the turn. Use on bears that try to lure you into dark alleyways.

**BICYCLE HELMET**

2 3 1

Slices through air as you frantically run from bears.

**BICYCLE HELMET**

2 3 1

Slices through air as you frantically run from bears.

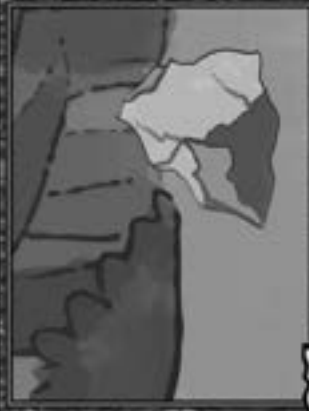
**Big Rock**

6  
5  
2



It's like a regular rock but rockier!

**Black Pepper**

-2  
2  
1

-2 Strength to a Bear or Camper until the end of the turn.  
Good for bears. Great for potato salad!

**Boots**

4  
4  
2

These boots were made for kicking and that's just what they'll do.

**Bug Spray**

-3  
3  
1

-3 Strength to a Bear or Camper until the end of the turn.  
Bugs? Bears? Close enough.

**Climbing Helmet**

3  
3  
1

If it can stop a rock from crushing your skull, it can stop a bear!

**Fishing Pole**

6  
3

Steal an equipped item or a random card from another Camper's hand.  
Just as good at snagging items as it is at catching fish.

**Hatchet**

4  
4  
2

If it's good enough for a posse of insane clowns, it's good enough for you.

**Faulty Compass**

3  
1

Select a Camper. That Camper's next turn is skipped.  
This compass's use is pretty polarizing.

### HIKER'S PACK

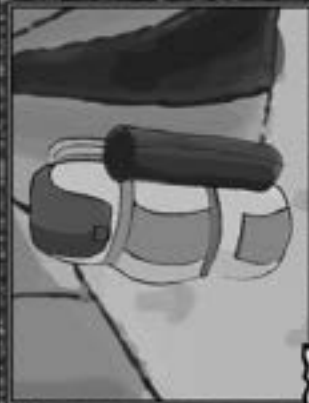

Hand icon: 4  
Foot icon: 4  
Eye icon: 4  
Heart icon: 2

It's like a backpack but with dozens of small, useless pockets.

### HIKING POLE

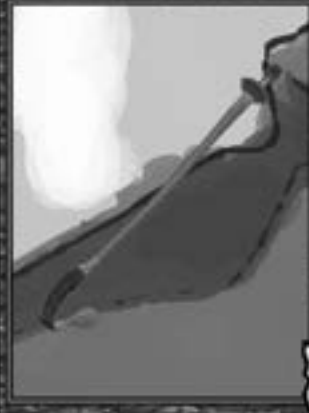

Hand icon: 3  
Foot icon: 3  
Eye icon: 3  
Heart icon: 1

It's like a ski pole but way less cool.

### HIKING POLE



Hand icon: 3  
Foot icon: 3  
Eye icon: 3  
Heart icon: 1

It's like a ski pole but way less cool.

### HONEY POT



Hand icon: 6  
Foot icon: 3  
Eye icon: 3  
Heart icon: 3

Choose one of the following effects:

- Skip a Camper's Battle Phase.
- A Camper must draw two Bears during their Battle Phase.

A distracting... or attracting treat!

### KNIFE



Hand icon: 5  
Foot icon: 5  
Eye icon: 5  
Heart icon: 2

There's more than one way to skin a bear. In fact, there are 50.

### KNIFE



Hand icon: 5  
Foot icon: 5  
Eye icon: 5  
Heart icon: 2

There's more than one way to skin a bear. In fact, there are 50.

### LEATHER JACKET

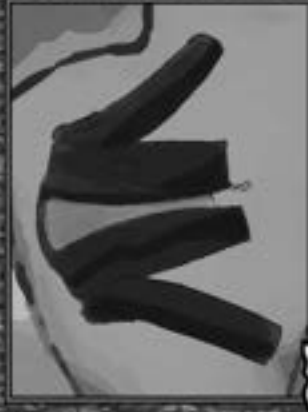

Hand icon: 3  
Foot icon: 3  
Eye icon: 3  
Heart icon: 1

You might sweat to death, but you'll sure as heck look cool down' it.

### LEATHER JACKET

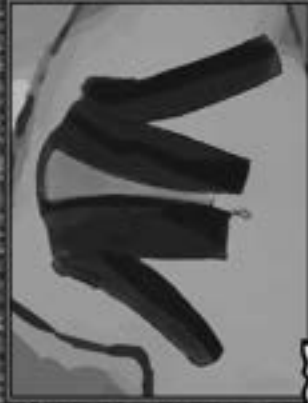

Hand icon: 3  
Foot icon: 3  
Eye icon: 3  
Heart icon: 1

You might sweat to death, but you'll sure as heck look cool down' it.

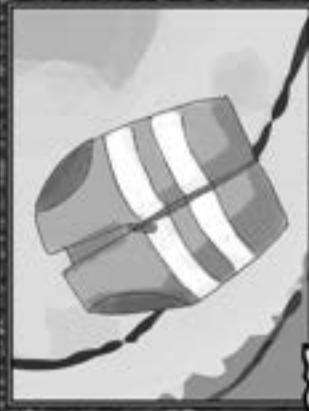
**LIFE VEST**

 2  2  1

Step 1. Safely float away from bears!  
 Step 2. Realize that bears can swim.  
 Step 3.

**LUMBERJACK BOOTS**

 5  5  2

Equipped with metal spikes to climb trees, these shoes are a bear's shin's worst nightmare!

**MALFUNCTION**

 4  4  2

Negate the activation of an Item card and discard it, or discard any Item card in play.  
*They don't make 'em like they used to.*

**MOTORCYCLE HELMET**

 4  4  2

If it can save you from a 50 MPH crash, it can save you from a bear attack. Possibly.

**POISONED PICNIC BASKET**

 -5  5  2

-5 Strength to a Bear or Camper until the end of the turn.  
 Soggy sandwiches and warm sodas are the bane of campers and bears alike.

**RAID**

 4  4  2

Steal one card at random from another Camper's hand.  
*You call it thievery, I call it a 'one-sided bar-faring system.'*

**RECYCLE**

 3  3  1

Shuffle the Item Discard Pile back into the Item Deck, then draw an Item card.  
*We all have to do our part!*

**ROCK**

 2  2  1

 / 
  
 Rocks from the company that brought you boulders!



**SACRIFICIAL SQUIRREL**

6 3

Cancel a fight between a Camper and a Bear. Place that Bear card at the bottom of its Bear Deck.  
*Sorry little buddy, but it's you or me.*

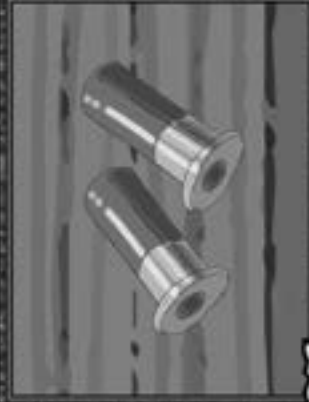
**SHELLS**

3 1

She sells these shells by the state store (not on Sundays).

**SHOTGUN**

5 6 3

The combined Strength of this card and the "Shells" item is 14.  
*Shotguns are like turtles. They require shells for optimal protection.*

**SLINGSHOT**

2 4 2

The combined Strength of this card and the "Rock" or "Big Rock" item is 11.  
*Perfect for taking down a goliath bear.*

**SNEAKERS**

3 3 1

Hopefully these will let you sneak past a sleeping bear.

**SNEAKERS**

3 3 1

Hopefully these will let you sneak past a sleeping bear.

**STICKY FINGERS**

8 4

Choose one of the following effects:  
• Draw an item card.  
• Steal an item card from Crazy Willie.  
• Steal an equipped item or a random card from another Camper's hand.  
*"Arribecker!"*

**STICKY FINGERS**

8 4

Choose one of the following effects:  
• Draw an item card.  
• Steal an item card from Crazy Willie.  
• Steal an equipped item or a random card from another Camper's hand.  
*"Arribecker!"*

**WOODEN OAR**



8 6 3

Hand icon

Paddles your boat, bare behinds, and bear behinds!

**TENT SPIKE**



4 4 2

Hand icon

Drive it into the ground or into a bear's face.

**TEAR GAS**



-5 5 2

Bear face icon

-5 Strength to a Bear or Camper until the end of the turn.  
Great for riots, bears, and riots composed entirely OF bears!

**STOCK TOKENS**

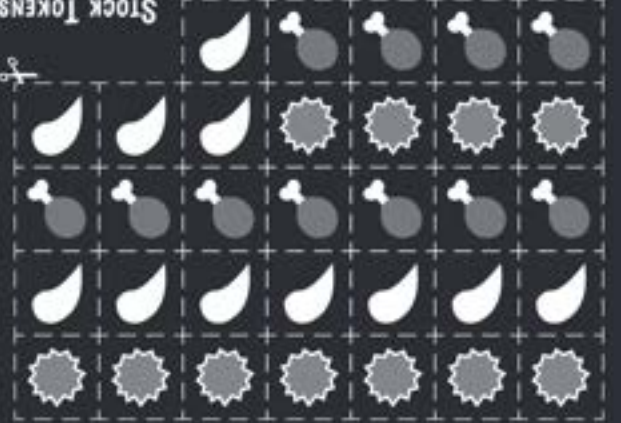

**STOCK**

1	2	3	4	5	6	7
8	9	★	11	12	13	14
15	16	17	18	19	★	21
22	23	24	25	26	27	28

**STOCK**

1	2	3	4	5	6	7
8	9	★	11	12	13	14
15	16	17	18	19	★	21
22	23	24	25	26	27	28